

7400-E

ELECTRICALLY
OPERATED
SYSTEMS
7400-E



G-RAIL[®]

ALUMINIUM RAIL

> *by Goelst*



Goelst electrically operated Roman blind system 7400-E.

Offering two motor options for medium and heavy-weight fabric covers - the smooth running tape guides ensure the blind remains perfectly level at all times.

Intermediate stopping of the blind at any desired height with the press of a button or switch - Infrared and radio remote control or integration into a home-automation system are all available with 7400-E. The system is available as 230V or 110V and is equipped with an automatic top and bottom limit switch.

Standard colours: White RAL 9010 and natural.

**ELECTRICALLY
OPERATED
SYSTEMS
7400-E**



7400-E > Electric blind

Installation

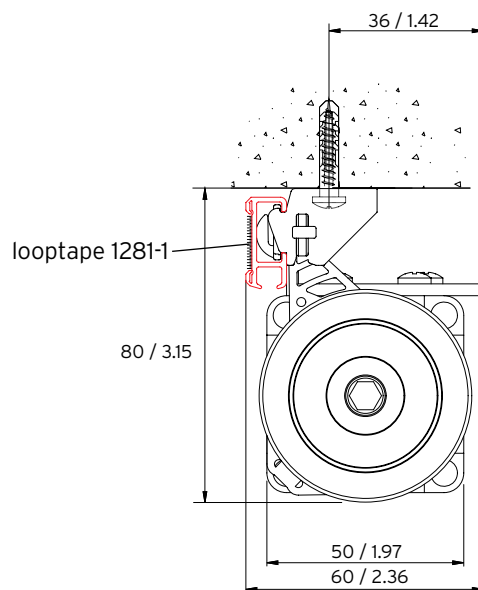

ceiling mounting with bracket 7450

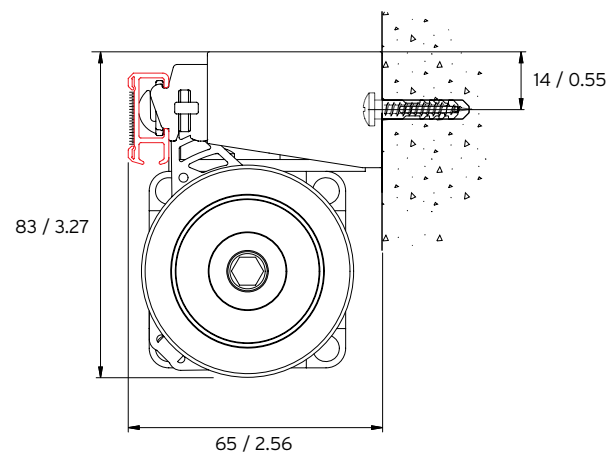

wall mounting with bracket 7451

Drawing dimensions are given in mm/inch.

Roman system.

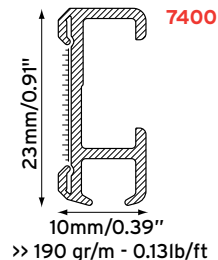
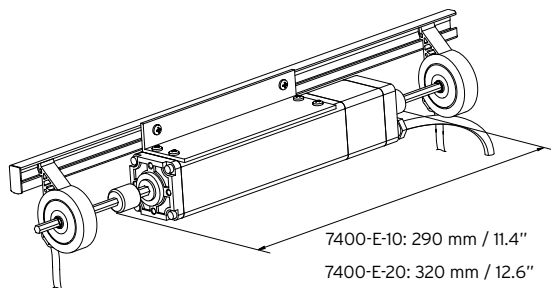

Specification Guide

Material:

Aluminium EN AW-6060 T66 (higher specification than DIN 1725). Shape and size tolerances are in accordance with EN12020 (DIN 17615). White RAL 9010 powder coated in accordance with the Qualicoat standard. Natural anodised in accordance with the Qualanod standard. Profile weight: 190 gr/m - 0.13 lb/ft.

Accessories:

Aluminium hexagonal profile 7411. Tape guide 7440. Female tape (pile) 1280-1. Endcap 7453. Counter weight 7490. U-joint 7425 for connecting aluminium hexagonal profile in bay-window applications.

Installation:

General advice for installation: an extra bracket should be installed at the curtain stacking positions. Ceiling fixing with bracket 7450. Wall fixing with bracket 7451.

We recommend the use of pan-head screws (not countersunk) when fitting brackets 7450 and 7451. Bracket fixing centres in accordance with the G-Standard or the following table.

| | | |
|---------------|---------------|-----------------|
| Light | medium | heavy (curtain) |
| 70cm / 2.29ft | 50cm / 1.64ft | 35cm / 1.15ft |

Control:

Standard control switch schematic.

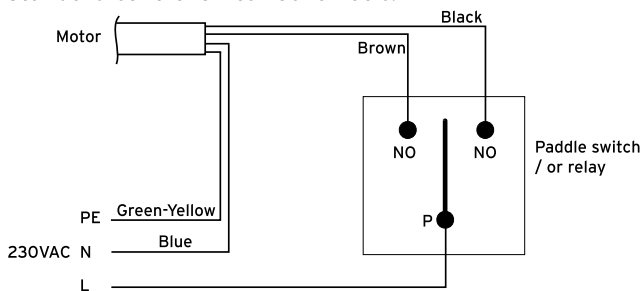

Bending:

Radius 10cm / 0.33ft. Bending machine 1015.

G-Standard (bracket fixing guide)

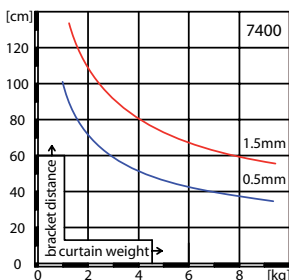

Product examples

Roman Blind

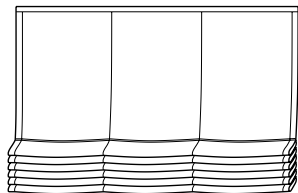

Swiss Blind

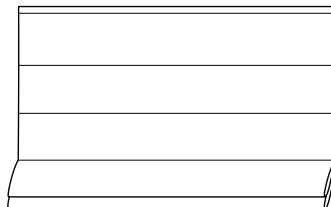

Greek Blind

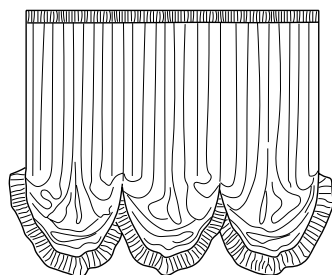
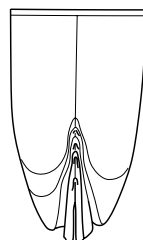

Austrian Blind

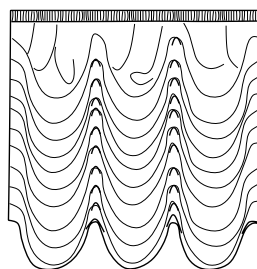

Venetian Blind

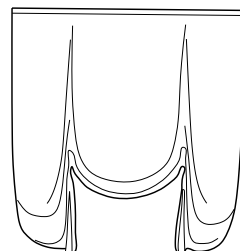

Belgian Blind

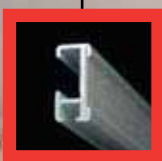

Exploded View

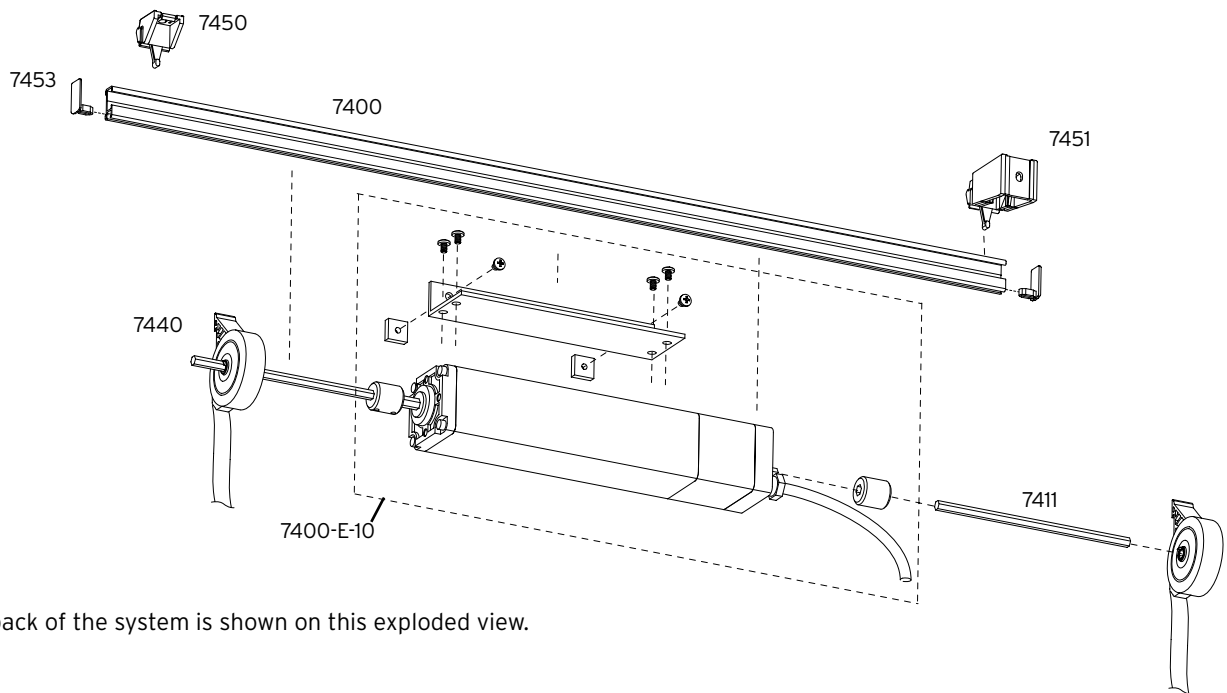

The back of the system is shown on this exploded view.

Product Example

Mounting at an angle with telescopic gliders and side profiles.

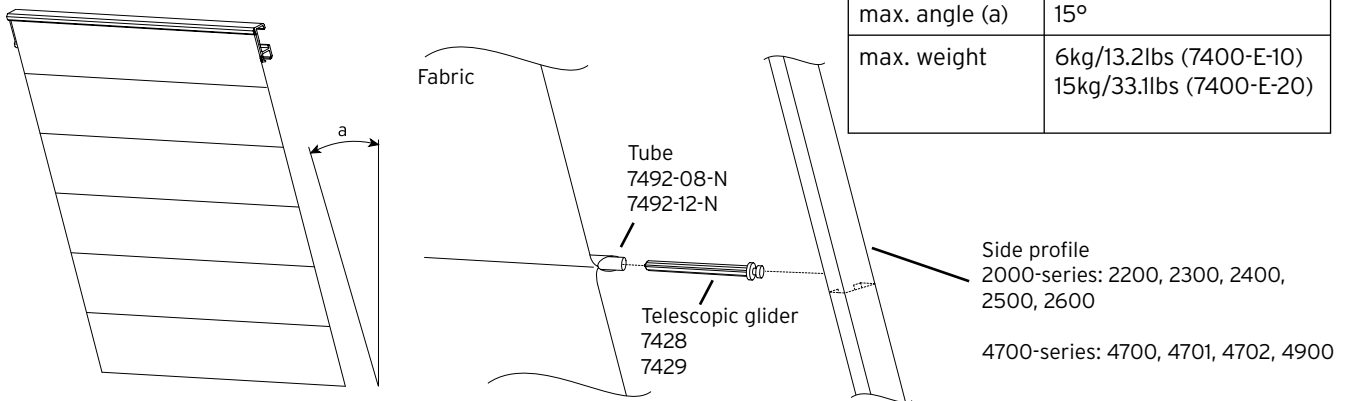



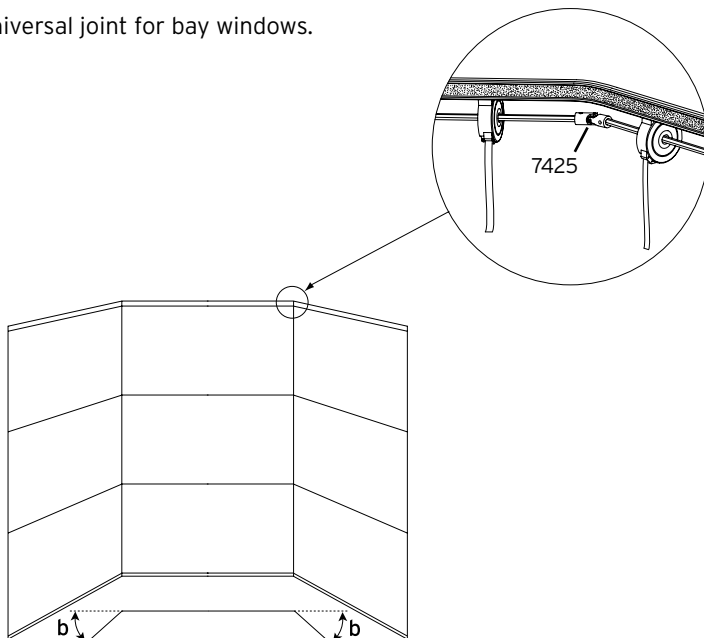





Universal joint for bay windows.

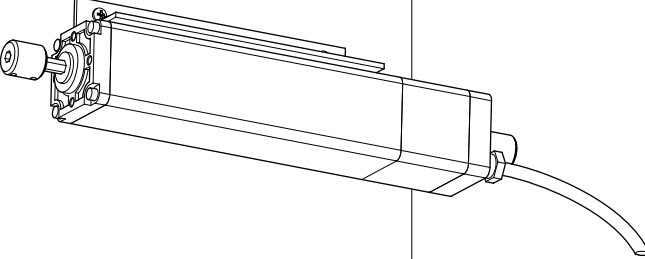
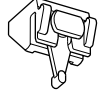

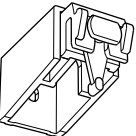
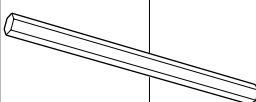
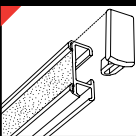
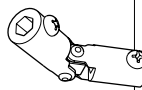
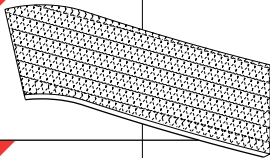
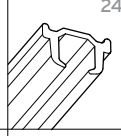
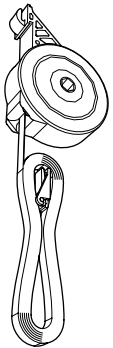
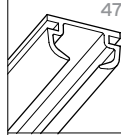
| 7400-E | |
|------------------------|---|
| max. angle (b) | 45° per connector 90° total |
| max. number connectors | 4x |
| max. weight | 6kg/13.2lbs (7400-E-10) 15kg/33.1lbs (7400-E-20) |

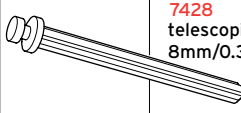
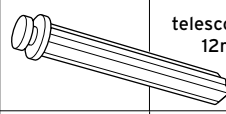
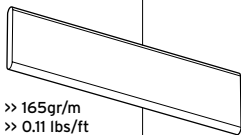
Components

Product design and specification changes reserved.

| | | | |
|--|---|---|---|
|  | | <p>7400-E-10 230V motor for 7400 max. load 9 kg / 19.8 lbs incl. connection support to rail incl. connection plug + cable (also available in 110V)</p> | <p>7400-E-20 230V motor for 7400 max. load 19 kg / 41.9 lbs incl. connection support to rail incl. connection plug (hirschmann) + cable (also available in 110V)</p> |
| FIXING | | | |
|  | <p>7450 ceiling bracket colours: B - W</p> |  | <p>7480-106 transp. ring 10mm/0.39"</p> <p>7480-138 transp. ring 13mm/0.51"</p> |
|  | <p>7451 wall bracket 6cm/2.36" proj. colours: B - W</p> |  | <p>7411 aluminium hexagonal profile colours: N</p> <p>>> 318 gr/m >> 0.21 lbs/ft</p> |
| ACCESSORIES | | | |
|  | <p>7453 end-cap colours: GR - W</p> |  | <p>7425 U-joint for aluminium hexagonal drive profile</p> <p>>> 62 gr/m >> 0.042 lbs/ft</p> |
|  | <p>1280-1 loop-tape</p> |  | <p>2000-series side profile for use with 2200, 2300, 2400, 2500 and 2600</p> <p>>> 97 gr/m >> 0.065lbs/ft</p> |
|  | <p>7440-300-10 tape guide + tape 300cm/9.8ft + transparent clip for tape (7426) colours: W</p> <p>7440-400-10 tape guide + tape 400cm/13.1ft + transparent clip for tape (7426) colours: W</p> <p>7440-550-10 tape guide + tape 550cm/18.0ft + transparent clip for tape (7426) colours: W</p> |  | <p>4700-series side profile for use with 4700, 4701, 4702 and 4900</p> |
|  | <p>7426 transparent clip for tape</p> |  | <p>7428 telescopic glider - small channel 8mm/0.31" for use with 7492-08-N</p> |
| CONTROL OPTIONS | | | |
| | |  | <p>7429 telescopic glider - wide channel 12mm/0.47" for use with 7492-12-N</p> |
| | |  | <p>7490-203R counter-weight 20x3mm/0.79"x0.12" colours: N - W</p> <p>>> 165gr/m >> 0.11 lbs/ft</p> |
| | |  | <p>Switch 2 way - centre off (paddle) switch for 230V</p> |
| | |  | <p>Radio Control see separate info sheet for NICE radio (RF) control options</p> |
| | |  | <p>Domotica alternative control options are available on request</p> |

**ELECTRICALLY
OPERATED
SYSTEMS
7400-E**

B = Brown
N = Natural
W = White

▶ = standard item

G-RAIL®