

Load Release System

PRIVACY RAIL
SYSTEMS

LOAD RELEASE



G-RAIL[®]

ALUMINIUM RAIL

> *by Goelst*



Inspired and developed by **Goelst**, this unique, patented system meets health care requirements for anti-ligature privacy rails. Designed to activate at an applied load of 35 kg +/- 2 kg, the **Load Release System** helps to protect against and reduce the risk of attempted patient self-harm. This system is designed for use with G-Rail 4100 and 5100.

PRIVACY RAIL SYSTEMS
LOAD RELEASE



LRS > Anti-ligature release s

Installation

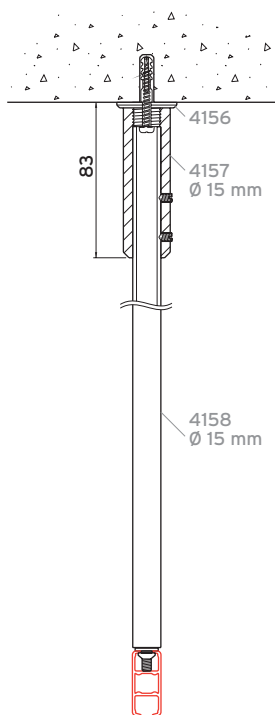

ceiling fixing 4100 with suspension hanger 4155-LRS

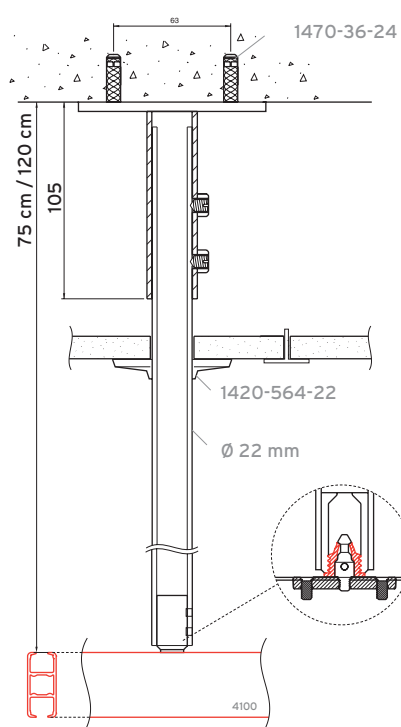

ceiling fixing 4100 with strut hanger 4064-LRS

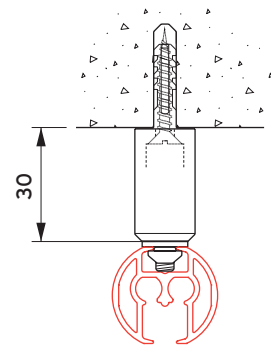

ceiling fixing 5100 with mini hanger 5149-LRS

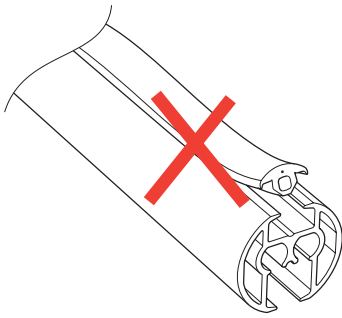

To further prevent risk of ligature, we advise not using dust cover.

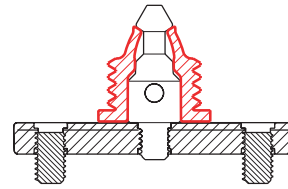

Specification Guide

Accessories:

Basic set 4159-LRS (for 4100) or 5159-LRS (for 5100).

Installation:

4100: ceiling fixing with mini suspension hanger 4154-LRS, suspension hanger 4155-LRS or strut hanger 4064-LRS. Wall fixing with wall support 4149-LRS. 5100: ceiling fixing with mini suspension hanger 5154-LRS, suspension hanger 5155-LRS or strut hanger 5064-LRS. Wall fixing with wall support 5149-LRS.

System details

This system allows the rail to release in a controlled manner when incorporated with privacy rail, shower rail or garment hanging rail. The Load Release System allows for normal rail use, but will separate at the Load Release Suspension Points when the calibrated control load is reached.

- continuous statical load up to 5 kg possible
- controlled release at peak load of 35 - 45kg

Maintenance and inspection

- Due to the ageing process of polymers, the effects of peak loading and or possible mis-use, we advise to check each Load Release Suspension Point for defects every 12 months from date of installation. We further recommend that all 4149-LR-R receiver units are replaced within 4 years of installation.
- It is advised that the LRS receiver unit is replaced immediately after the system has been activated.

re load system for privacy rail.

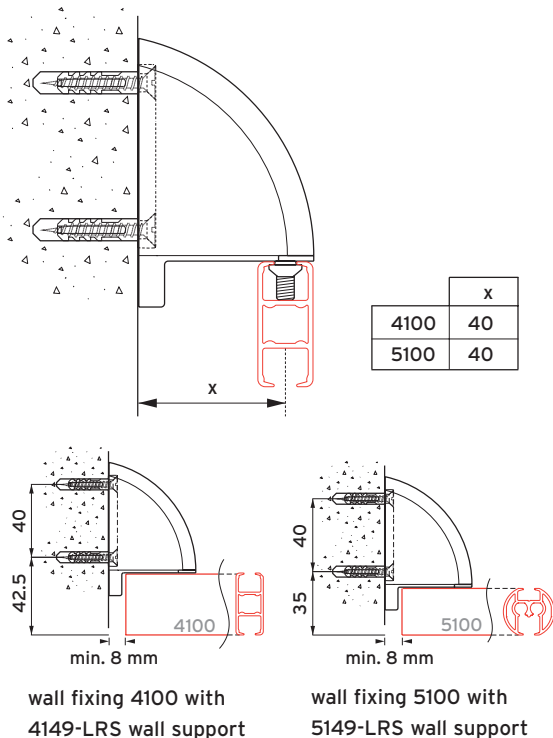

For complete system analysis refer to technical documentation (available on request).

Fixing points and release loads

Fixing advice for 4100 rail with Load Release System suspension hangers and wall supports:

In the diagram below, privacy rail 4100 is shown fixed with suspension hangers and wall supports. The release loads are given in red and the measured deviation is given in black. For further fixing recommendations, please refer to the Load Release System Technical Report which is available on request.

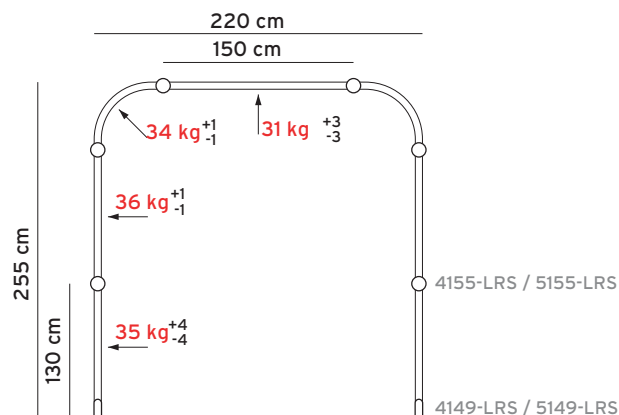

Release loads

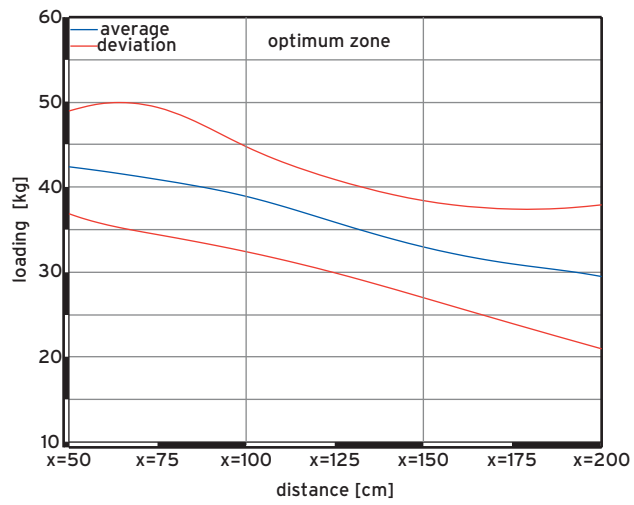

In the above graph, the release load is shown with increasing fixing centres (x). In the optimum zone, the release load is at the desired levels with only a small deviation from these values being expected. At fixing centres greater than 150 cm, the release load becomes less predictable.



Exploded view

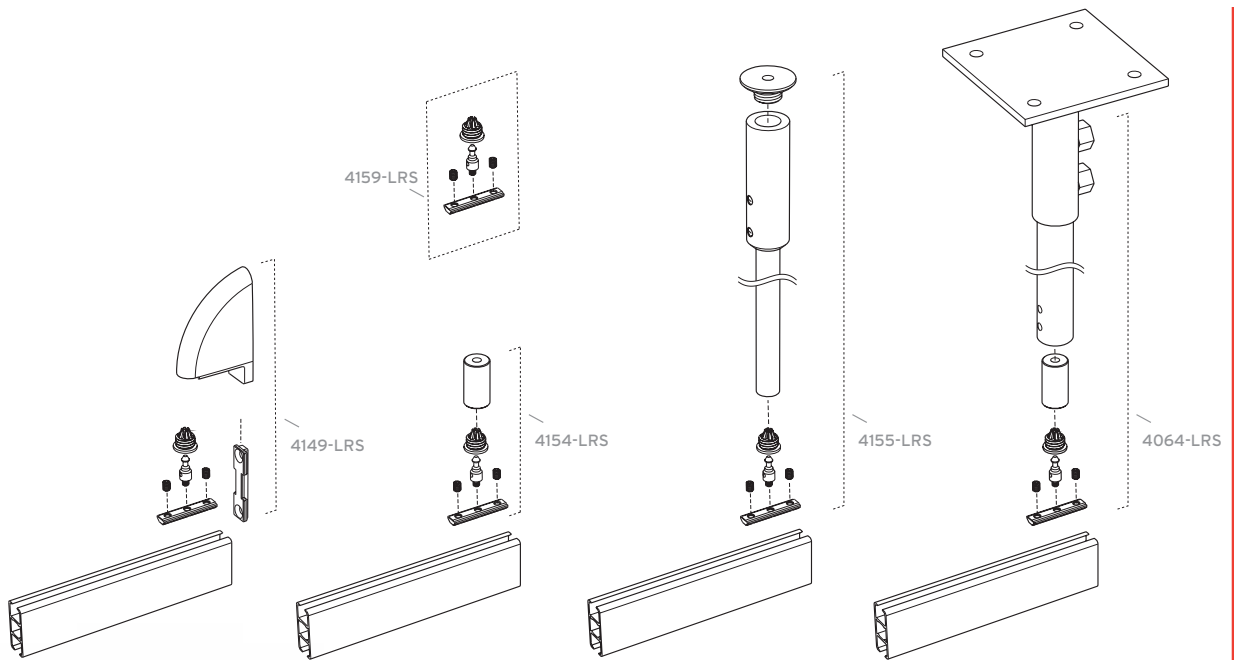

Product example: room with 4100 rail

The various applications of the LRS are illustrated below.

1. window rail

For a release load between 30 and 40 kg with a straight window rail: The fixing centres (y) should preferably be between 75 cm and 125 cm. The value of other fixing centres (x) should be twice this distance.

2. privacy rail & 3. shower rail

for a release load between 30 and 40 kg:
fixing centres (x) should be between 100 cm and 150 cm
and distance (b) should be between 25 cm and 75 cm.

4. wall-wall installation



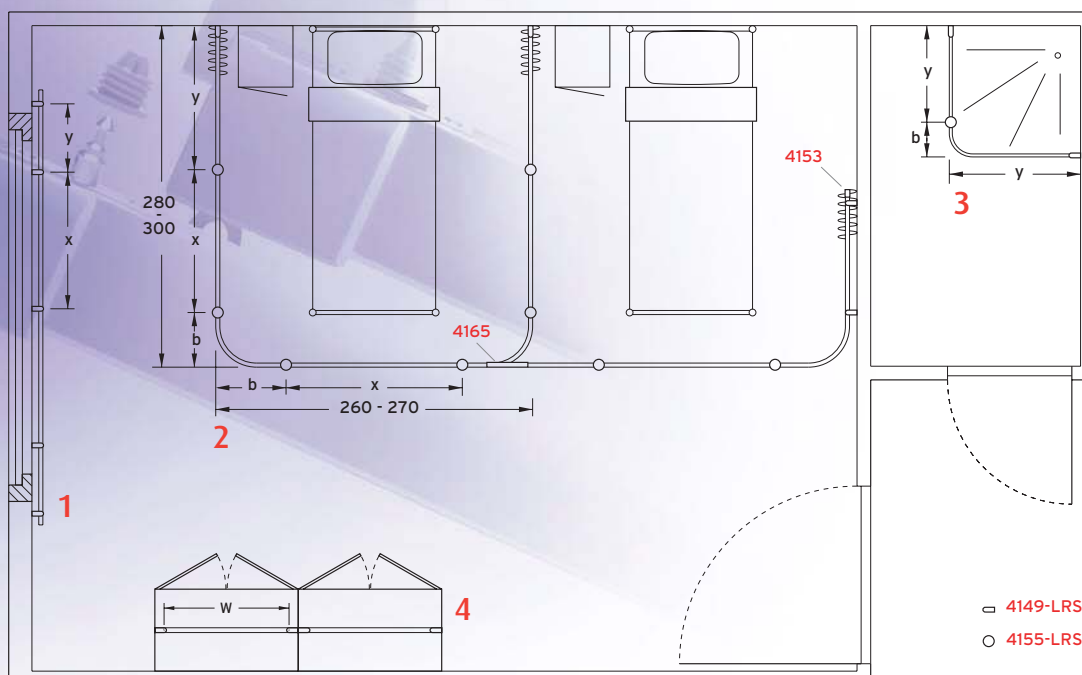

For application as e.g. a wardrobe garment hanging rail:
Width (w) should not exceed 100 cm for rail 5100 or 125 cm for rail 4100. For larger widths additional suspension hangers (4155-LRS or 4154-LRS for 4100 or 5155-LRS or 5154-LRS for 5100) will be required.

The values mentioned above do not include the weight of the rail or the curtain.
In drawing below, typical cubical dimensions are given as an illustration only.



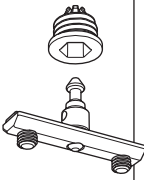

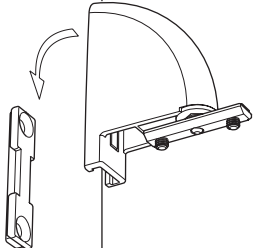
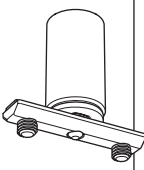
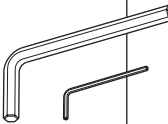
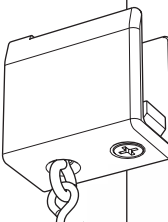
Components

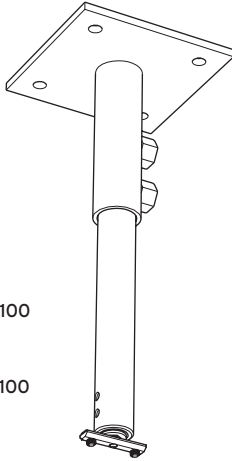
Product design and specification changes reserved.

BASIC SET	
	<p>4159-LRS [Ⓟ] basic set LRS for 4100 (incl. seal)</p> <p>5159-LRS [Ⓟ] basic set LRS for 5100 (incl. seal)</p>
	<p>4159-LR-R [Ⓟ] receiver unit (incl. seal)</p>
WALL FIXING	
	<p>4149-LRS wall support for use with 4100</p> <p>5149-LRS wall support for use with 5100</p> <p>colours: W - GR</p>
CEILING FIXING	
	<p>4154-LRS mini suspension hanger 3 cm for 4100</p> <p>5154-LRS mini suspension hanger 3 cm for 5100</p> <p>colours: W - N</p>
ACCESSORIES	
	<p>1003-7: hexagonal key 7mm for use with receiver</p> <p>1003-2: hexagonal key 2mm for grub screws for track insert</p>
	<p>4153-LR end cover set for use in combination with 4149-LRS</p> <p>colours: W - GR</p>
	<p>4155-LRS suspension hanger for 4100</p> <p>5155-LRS suspension hanger for 5100</p> <p>colours: W - N</p>
	<p>4064-LRS strut hanger for 4100</p> <p>5064-LRS strut hanger for 5100</p> <p>colours: W - GR</p>

PRIVACY RAIL SYSTEMS
LOAD RELEASE

W = White
N = Natural
GR = Grey

 = standard item
 = patented

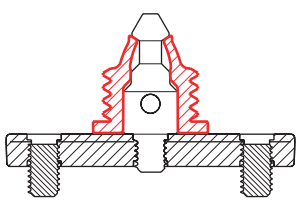

Warranty

This system must be installed and used strictly in accordance with the instructions in the Load Release System Technical Report (available on request). Although detailed attention has been paid to making sure the various components of the Load Release System function correctly, we cannot rule out the possibility that individuals may be successful in harming themselves. Therefore the supplier and manufacturer cannot be held liable for resulting injury, loss or damage due to aggression, misbehavior, carelessness, or by not adhering to the instructions in the Load Release System Technical Report.



Space for dealer address