

4100

PRIVACY RAIL
SYSTEMS

4100

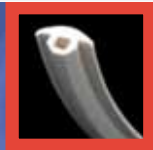

G-RAIL[®]
ALUMINIUM RAIL

> *by Goelst*



G-Rail 4100 is a strong, functional and fully reversible profile.

Conforming to HTM66, series 4100 offers a comprehensive range of accessories to suit all fixing possibilities. Elegant in design and function 4100 is suitable for use with up-lighters for improved ambient hospital ward lighting. Synthetic wall and ceiling fittings allow rail 4100 to comply with the European NEN-3134 standard for special care rooms requiring anti-static facility.

Standard colours: White RAL 9010, natural.

PRIVACY RAIL SYSTEMS
4100



4100 > Cubicle rail priv

Installation

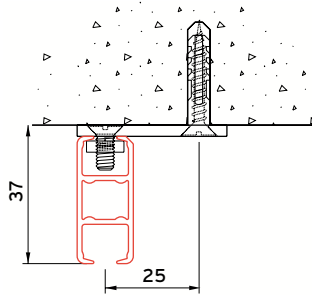

ceiling fixing with plate 4135

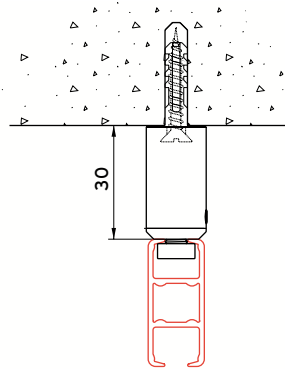

ceiling fixing with mini suspension hanger 4254

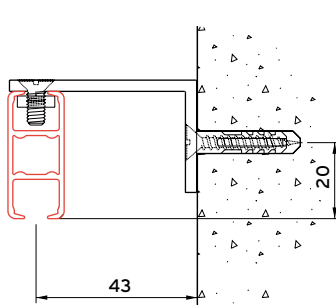

wall fixing with bracket 4141

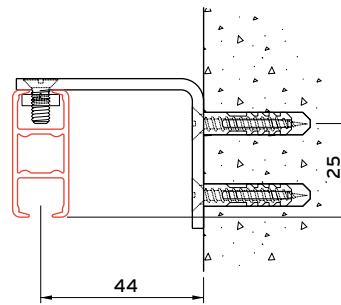

wall fixing with bracket 4140

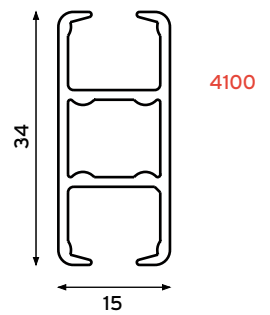

Specification Guide

Material:

Aluminium 606035-T6-F22. (Higher specification than DIN 1725).
 Shape and size tolerances are in accordance with DIN 17615.
 Satin silver anodised / powder coat white RAL 9010 in accordance
 with the Qualicoat standard. Special colours available on request.
 Profile weight: 394 g/m.

Accessories:

Glider-hooks 4008 (rotating glider with SS hook) at 10 per metre,
 two end stops 4002 per length. Dust cover 4145 and connecting
 bridge 4165 to suit.

Installation:

Ceiling fixing with 4135 ceiling fixing plate, 4254 mini suspension
 hanger, 4155 suspension hanger, 4160 or 4161 V hanger, 4064 strut
 hanger with plate.
 Wall fixing with 4150 wall support, 4141 wall bracket or 4140 plexi-
 glass wall bracket.

for room dividing and privacy in the healthcare se

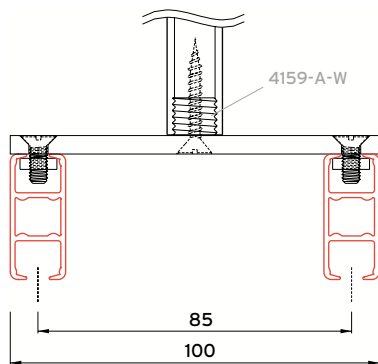

parallel rail fixing with bridging plate 4116-10

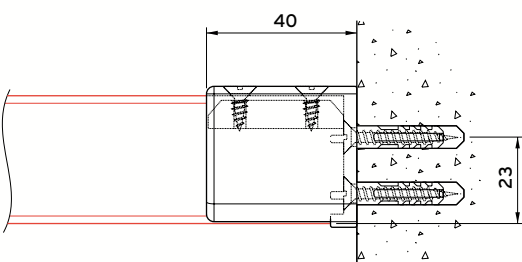

wall fixing with bracket 4150

This system can also be mounted with anti-ligature Load Release
 components, to provide a controlled system collapse.

NEN-3134: Isolated fixing in S3 (anti-static) rooms.

Ceiling fixing with suspension hanger 4155 (using synthetic ceiling
 stud 4156), wall fixing with plexiglass wall bracket 4140 and
 synthetic wall support 4150. An earth cable needs to be connected.

Bracket distance in accordance with G-Standard or the following
 table:

light	medium	heavy	(curtains)
240*)	180*)	120 cm	

*) Please take into account the lateral deflection within the rail.
 This effect can be reduced by using a V-hanger or strut-hanger
 with fixing plate.

Bending:

Minimum radius 20 cm, using bending machine 1015.

Product example

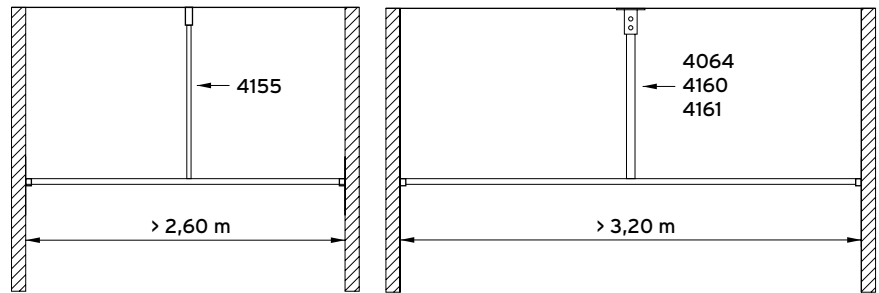

This picture shows when a 'strut-hanger' (4064) or V-hanger (4160/4161) is used and when a vertical suspension hanger (4155) is sufficient.

G-Standard (bracket fixing guide)

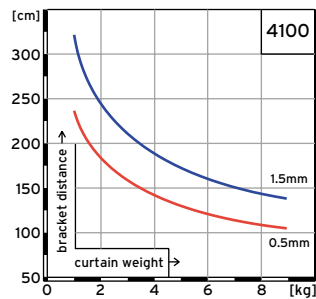

ctor.



Installation (continuation)

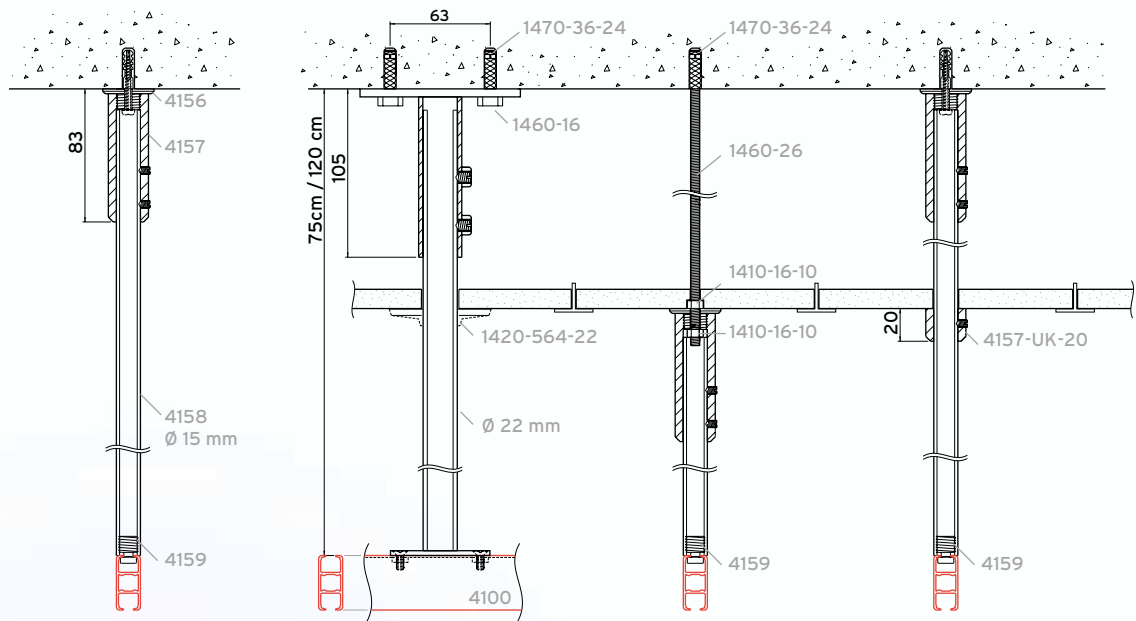

ceiling fixing with suspension hanger 4155

ceiling fixing with strut hanger 4064 through suspended ceiling tiles

ceiling fixing with suspension hanger 4155 and M6 threaded rod through suspended ceiling tiles

ceiling fixing with suspension hanger 4155 through suspended ceiling tiles with dummy ceiling support 4157-UK-20 (or ceiling rose 1420-555-15)

4159: Synthetic thread M12.

Product example

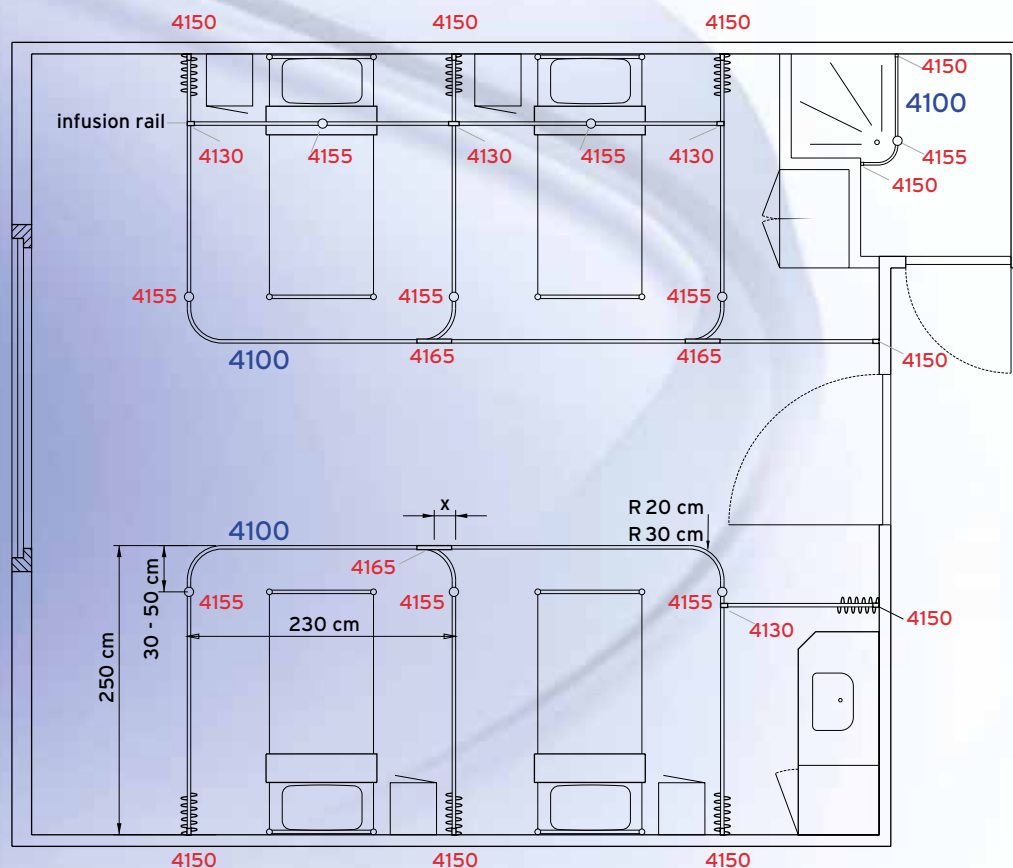









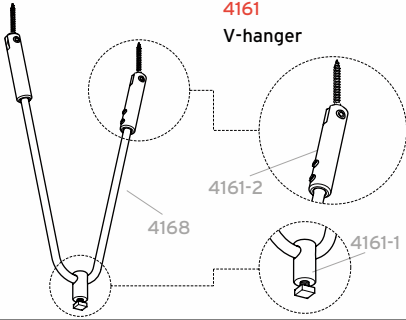
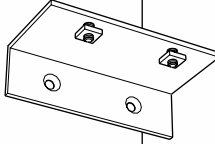

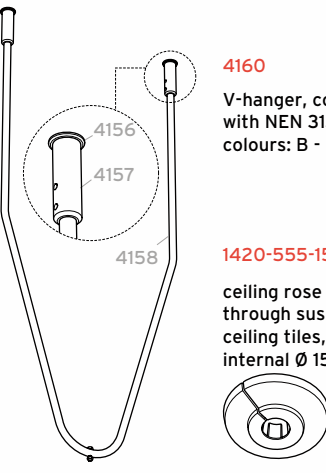
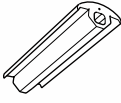
x = connecting bridge over-sail

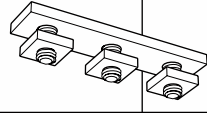
25 cm at R30
13,5 cm at R20

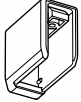
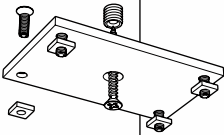
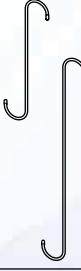
Components

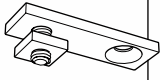
Product design and specification changes reserved.

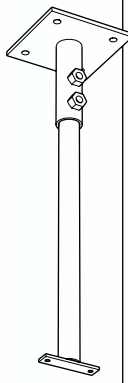
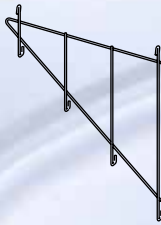
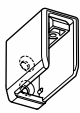
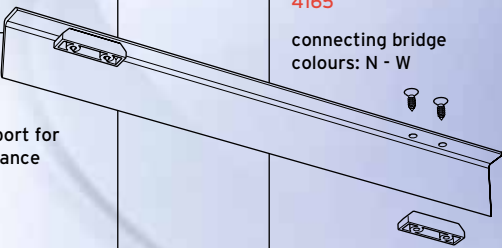
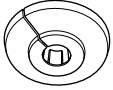
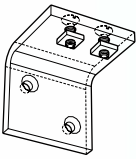
CURTAIN TRANSPORT					
	4002 end stop		4161 V-hanger		4141 wall bracket colours: N - W
	4003 spring stop		4160 V-hanger, complies with NEN 3134 colours: B - N - W	ACCESSORIES	
	4007 rotating glider		1420-555-15 ceiling rose when fixing through suspended ceiling tiles, internal Ø 15 mm		4145 dust cover colours: B - GR - W
	4008 rotating glider with SS-hook			4130 T-junction for right angle connections colours: N - W	
	4013 rotating glider with ring for 4180 and 4181			4153 end cover colours: GR - W	
CEILING MOUNTING			4116-10 bridging plate with hole 4116-20 : without hole colours: N - W		4181-30 infusion hook 30 cm
	4155 suspension hanger, complies with NEN 3134 colours: B - G - N - W		4135 ceiling fixing plate colours: N - W		4170 curtain holdback with fixing plate colours: N - W
	componentry when fixing through suspended ceiling tiles: 1420-555-15 ceiling rose 4157-UK-20 dummy support		4254 suspension hanger 3 cm colours: B - G - N - W		
	4064 strut hanger, inclusive of fixing screws and Ø 22 mm ceiling rose (scan plate) when fixing through suspended ceiling tiles colours: GR - W	WALL MOUNTING			4180 infusion bottle hanger
	ceiling rose 1420-564-22 (inclusive) internal Ø 22 mm		4150 wall support, complies with NEN 3134 colours: GR - W		4165 connecting bridge colours: N - W
			4140 plexiglass wall support for mounting in accordance with NEN 3134		

PRIVACY RAIL SYSTEMS

4100

B = Brown
G = Gold
GR = Grey
N = Natural
W = White

▲ = standard item
NEN 3134: anti-static legislation

G-RAIL®

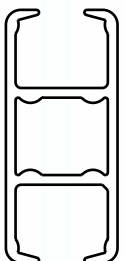

4100

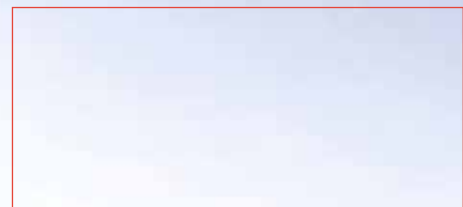

Space for dealer address

06/2003